

INSTRUCTION MANUAL
for
THE
NATIONAL MODEL
NC-2-40CS

A
UNIVERSAL
COMMUNICATIONS
RECEIVER

A high performance receiver of advanced design for the 200 to 400 and 1,000 to 30,000 kilocycle range.

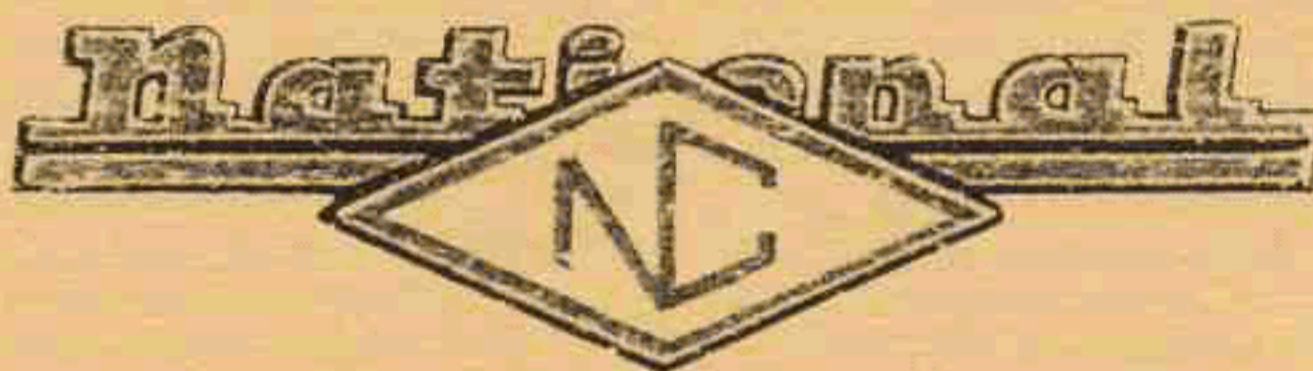

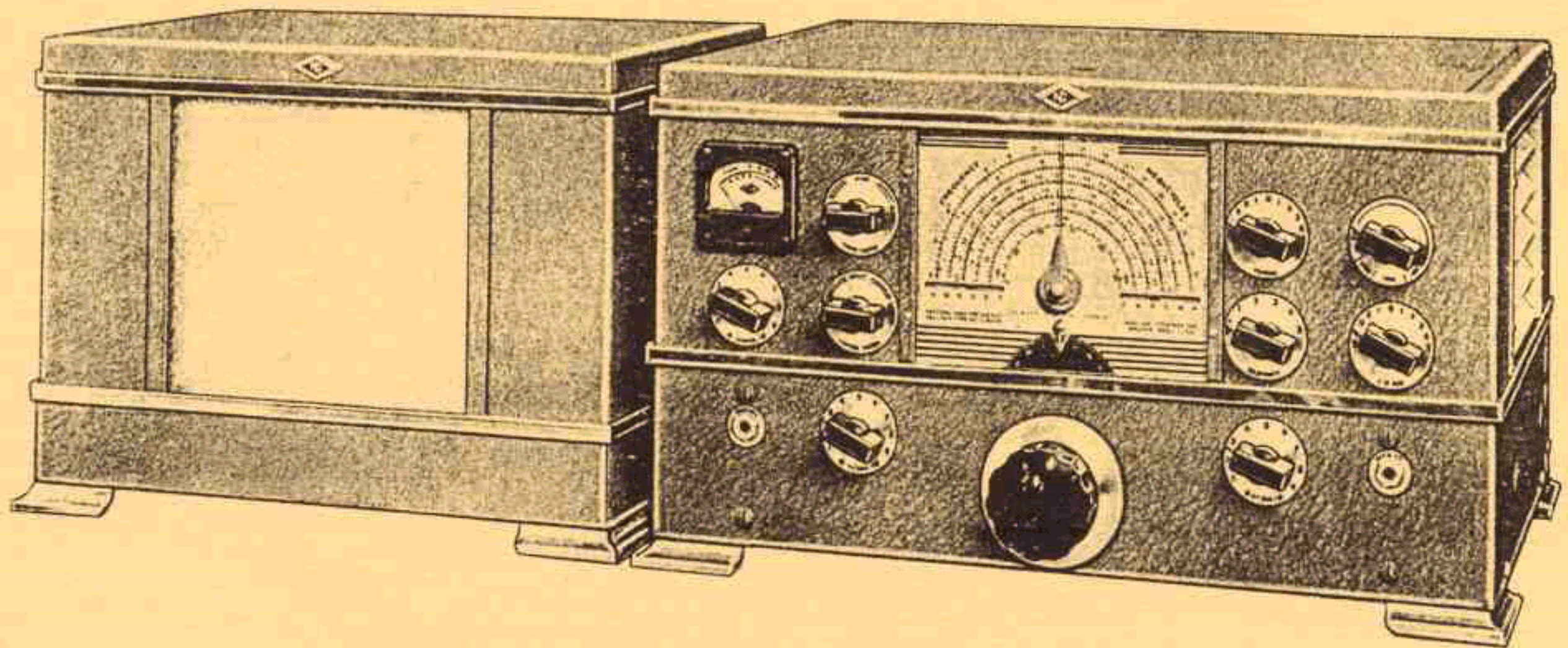

NC-2-40CS RECEIVER

HIGHLIGHTS . . .

- 200 to 400 and 1,000 to 30,000 Kilocycle Range.
- 10,000, 500 and 8 Ohm Output Impedances.
- 6 Tuning Bands with Definite, Accurate Calibration.
- Actual Single Dial Control.
- Automatic, Adjustable-Threshold Noise Limiter.
- New, Flexible Crystal Filter.
- Temperature Compensation.
- Automatic Voltage Stabilization.
- 115 and 230 Volt, 50/60 Cycle Operation.
- Phonograph or High-Level Microphone Pick-up Jack.

THE NC-2-40CS COMMUNICATIONS RECEIVER

SECTION 1. DESCRIPTION

1-1. General

The NC-2-40CS RADIO RECEIVER is a superheterodyne employing eleven tubes plus a rectifier with a frequency range of from 200 to 400 and 1,000 to 30,000 kilocycles. Many new features of recent design are incorporated in this Receiver. An automatic noise limiter with adjustable threshold provides a means of effectively reducing interference caused by external noise pulses. The sensitivity of the NC-2-40CS is particularly high, an input signal of only 1 microvolt providing 1 watt of audio output. R.F. coupling circuits designed in the National Laboratories have made possible the maintenance of full sensitivity up to the highest frequencies covered by the Receiver. The crystal filter employed in the NC-2-40CS provides six uniform steps of selectivity variation plus a phasing control for the reduction of interfering heterodynes.

A high degree of oscillator stability is achieved in the NC-2-40CS Receiver. Perhaps the best way to prove the exceptional performance of the high-frequency oscillator circuit is at 30.0 Mc., where a line voltage shift from 100 to 120 volts produces less than 1,000 cycles change in tuning, a variation of less than 0.003 percent. Frequency drift due to temperature effects has been reduced to a minimum through the use of temperature compensating capacitors in the high-frequency and C.W. oscillator circuits.

The standard NC-2-40CS Receiver is designed for operation from a 110/120 or 220/240 volt, 50/60 cycle power source, or from batteries furnishing the required voltages.

1-2. Circuit

The circuit employed on all bands consists of one stage of radio frequency amplification, a separate first detector and stabilized high frequency oscillator, two intermediate frequency stages, an infinite impedance second detector, a self-balancing phase inverter and audio amplifier, and a push-pull audio output stage.

The second detector utilizes one set of elements of a dual triode; the other set of elements is utilized for a series valve noise limiter. Separate tubes are used in the automatic volume control and beat frequency oscillator circuits. The latter is coupled to the second detector for C.W. reception.

A crystal filter is connected between the first detector and first I.F. amplifier tubes.

All voltages required by the Receiver circuits are supplied by a built-in power supply.

1-3. Tube Complement

The NC-2-40CS is supplied complete with tubes which are tested in the Receiver at the time of alignment.

The tubes employed are as follows:

R. F. Amplifier.....	6SK7
First Detector.....	6K8
H. F. Oscillator.....	6J5
First I. F. Amplifier.....	6K7
Second I. F. Amplifier.....	6SK7
Second Detector-Limiter.....	6SL7GT/G
Automatic Volume Control.....	6V6
Beat Frequency Oscillator.....	6SJ7
Amplifier and Phase Inverter.....	6SN7GT/G
Push-Pull Audio Output (2).....	6V6
Rectifier.....	5Y3G

1-4. Tuning System

The master tuning capacitor C-1 and six sets of coils are used to tune the frequency range of the Receiver in six tuning bands.

The frequency coverage of the six bands is as follows:

Band A	14.0-30.0 Mc.
Band B	7.0-14.4 Mc.
Band C	3.5- 7.3 Mc.
Band D	1.7- 4.0 Mc.
Band E	1.0- 2.0 Mc.
Band F	200- 400 Kc.

All transformer coils of the P.F. amplifier, first detector and H.F. oscillator stages with their associated padder and air-dielectric trimmer capacitors are mounted in a rigid aluminum casting which

slides the length of the chassis, being moved by the MAIN TUNING control. The various coil assemblies are fitted with heavy contact pins which engage spring contactors mounted immediately under the variable tuning capacitor. This system permits thorough shielding of each individual coil while, at the same time, the coils in use are moved to the best position in the chassis, giving shortest leads to the tubes and master tuning capacitor, and all other coils are completely disconnected from the circuit.

1-5. Crystal Filter

Undoubtedly, the most efficient, flexible crystal filter yet designed is used in the NC-2-40CS Receiver. Six uniform steps of selectivity, as shown in Fig. No. 1, and a variable phasing control allow the receiver to be adjusted to almost any operating condition, a highly desirable feature for both short wave communication and broadcast band reception. The curves show that any degree of selectivity between that of full single signal operation and wide

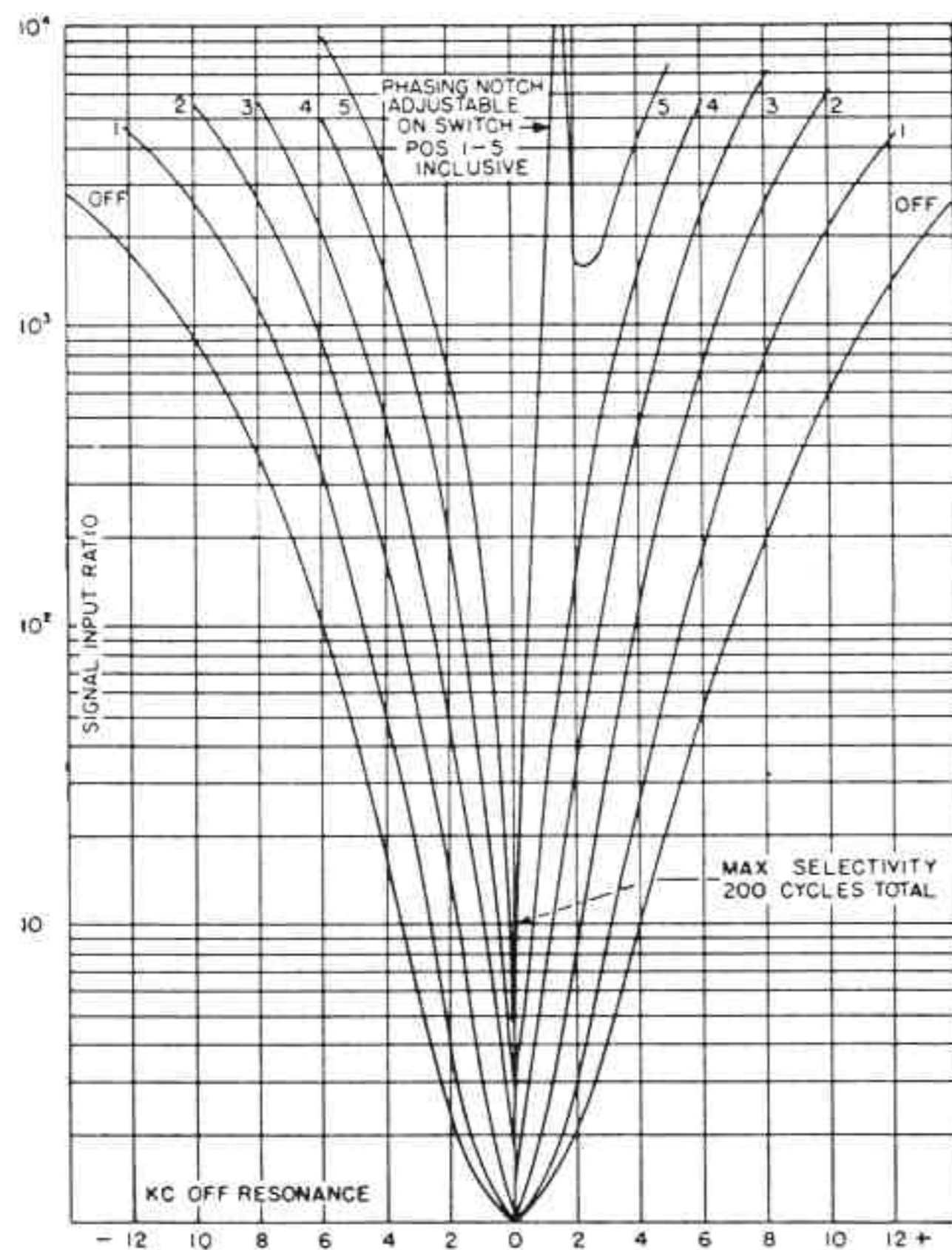

Fig. No. 1. Typical Selectivity Characteristics

band broadcast reception is available, the ratio between the two being almost forty to one.

1-6. Noise Limiter

The new noise limiter of the NC-2-40CS Receiver is of the automatic, adjustable-threshold, series valve type developed in the National Laboratories. The limiter is double-acting--limiting noise on both positive and negative peaks. The usefulness of this limiter will be most appreciated on the higher frequency bands where ignition noise and other high frequency disturbances are effectively suppressed.

1-7. Tone Control

The tone control is used to vary the frequency characteristic of the audio amplifier. The control is particularly helpful when receiving weak signals through interference, as explained in Section 3.

1-8. Signal Strength Meter

A 0 to 1 millimeter, serving as a signal strength meter, is front panel mounted. It is fitted with a scale in S-units from 1 to 9 (5db. per S-Unit) and in db. above S-9 from 0 to 40db. The circuit, in which the meter is connected, makes possible accurate signal input readings from below 1 microvolt to 5,000 microvolts.

1-9. Antenna Input

Antenna input terminals are located at the rear of the receiver chassis near the center. The input circuit is suitable for use with a single wire antenna, a balanced feed-line or a low impedance concentric transmission line. Average input impedance is 300 ohms.

1-10. Audio Output

(1) A headphone jack is mounted on the front panel and is wired so as to silence the loudspeaker when the phone plug is inserted. The correct load impedance for the headphone circuit is 20,000 ohms, this being the usual impedance of phones having a D.C. resistance of between 2,000 and 3,000 ohms. Maximum audio output available at the phone jack is 15 milliwatts.

(2) A five prong socket (X-1) is provided at the rear of the Receiver for con-

nection to the loudspeaker furnished with the NC-2-40CS. The audio output leads are brought directly to this socket. The proper load impedance (total) for the output connection is 10,000 ohms. Maximum undistorted audio power available is 8 watts.

(3) Two additional audio output connections are brought out to terminal strips (X-3 and X-4) from the output transformer (T-5). The proper load impedances for connection to these output circuits are 8 and 500 ohms, respectively. The 500 ohm terminal (X-4) is suitable for connection to a 500 ohm telephone line.

1-11. Power Supply

The standard NC-2-40CS Receiver is designed for operation from a 110/120 volt, or 220/240 volt, 50/60 cycle power source. A toggle switch is provided in the dual primary circuit of the power transformer to permit operation from either voltage. Normal power consumption is approximately 80 watts. The built-in power supply delivers all voltages required by the heater and B supply circuit - 4.5 amperes at 6.3 volts and 100 milliamperes at 250 volts, respectively. One side of the A.C. input line is connected through a 2 ampere and a 1 ampere fuse each housed in an extractor post marked 'FUSE' mounted at the rear of the receiver chassis. The 2 ampere fuse is used in the circuit for 115 volt operation;

both 2 and 1 ampere fuses are used for 230 volt operation.

All NC-2-40CS Receivers are equipped with a seven prong plug and socket combination to permit portable or emergency operation from batteries; See Section 2-3.

1-12. Loud Speaker

The loudspeaker supplied with the table model NC-2-40CS Receiver is of the permanent magnet field type having a nominal diameter of 10 inches. A coupling transformer, mounted on the loudspeaker chassis, matches the voice coil to the output impedance of the Receiver. A shielded three wire cable and plug is furnished for connection between the loudspeaker and receiver.

A cabinet, finished to match the Receiver, houses the loudspeaker for table mounting.

1-13 Pick-up Jack

A pick-up jack mounted on the front panel of the Receiver may be used to connect auxiliary apparatus, such as phonograph pick-up, to the audio system of the NC-2-40CS Radio Receiver. This input circuit is high impedance and feeds into the 6SN7GT/G, Audio Amplifier-Phase Inverter tube. The TONE and A.F. GAIN controls are operative with this connection.

SECTION 2. INSTALLATION

2-1. Antenna Recommendations

When using a single-wire antenna, the lead-in should be connected to one antenna input terminal and the short flexible lead, which is attached to the chassis, should be fastened to the other terminal. The dimensions of the single-wire antenna system are not critical, the recommended length, including lead-in, being from 75 to 100 feet, although any length between 25 and 200 feet may be used.

Feed-lines of doublet systems should be connected to the two input terminals. The flexible lead is not used.

The inner conductor of a concentric transmission line should be connected to one input terminal. The outer conductor

and the flexible grounding lead should be connected to the other terminal.

An external ground connection to the chassis may or may not be necessary. It should be used unless it reduces signal strength.

2-2. AC Operation

After unpacking the NC-2-40CS Receiver and loudspeaker from the shipping cases, proceed as follows:

(1) Remove the two coil carriage locking screws on the right-hand side of the cabinet before attempting to slide the coil carriage.

(2) Make sure tubes are firmly in their sockets.

(3) Insert the dummy connector plug

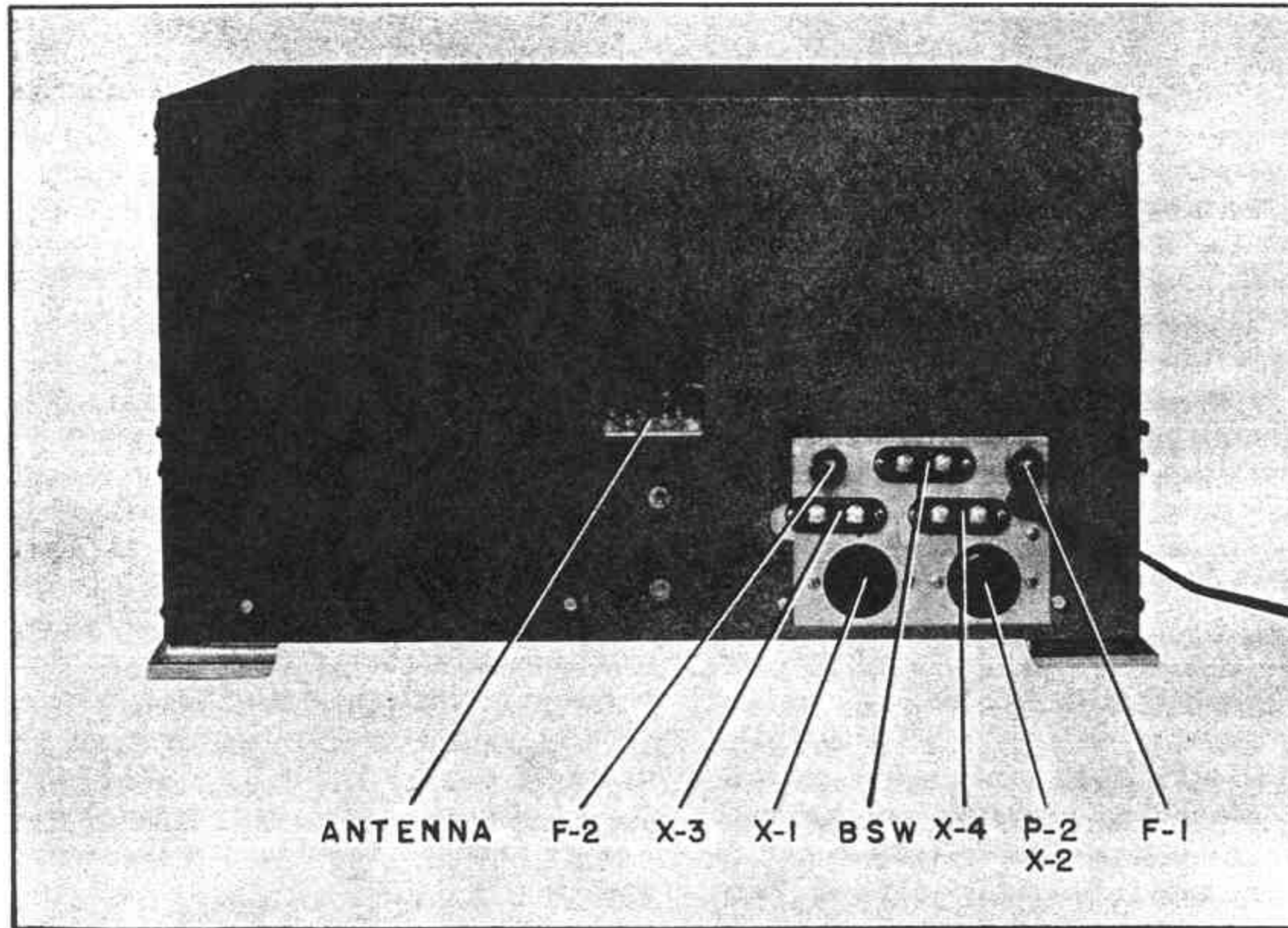

Fig. No. 2. Rear View of Receiver (B.S.W. Shield Removed)

P-2 in the seven prong socket X-2.

(4) Insert loudspeaker plug P-1 in the five prong audio output socket X-1 of the Receiver.

(5) Connect antenna feed line.

(6) Set primary selector switch for line voltage to be used i.e. 115 or 230.

(7) Plug A.C. line cord in proper source of supply.

(8) Set controls as recommended in Section 3 for reception of signals.

2-3. Battery Operation

The NC-2-40CS may be operated in portable or emergency service by connecting batteries to the terminals of battery connector plug P-3 and inserting it in socket X-2, in place of plug P-2. See Fig. No. 2. For normal operation with somewhat reduced loudspeaker output, a 6 volt heater supply (storage battery) should be connected to terminals 1 and 7 of plug P-3, and a 180 volt B supply should be connected to plug terminals 4 and 5. The jumper between terminals 2 and 3 (of P-3) completes the plate and screen supply circuits of the 6V6 output tubes. The jumper may be omitted, with greater battery economy, when opera-

tion with head phones only is desired. A suggested refinement is to connect a switch between terminals 2 and 3, thus permitting the 6V6 B supply to be opened at will. A further economy of battery power may be effected by removing the 6V6 tubes from their sockets. During battery operation the B+ and B.S.W. switches are operative. The A.C. line switch does not render the Receiver inoperative during battery operation. It is necessary, therefore, to remove the battery plug to disconnect the battery from the Receiver.

Do not attempt to use plug P-2 for battery connection, since the jumper between terminals 6 and 7 would be incorrect.

The recommendations of Section 3, OPERATION, apply also to the battery powered NC-2-40CS.

2-1. Loud Speaker

If the installation is such that the loudspeaker will be placed close to the Receiver, the most desirable position is at the side. Placing the loudspeaker on top of the Receiver is not recommended since undesirable "microphonics" may result.

SECTION 3. OPERATION

3-1. Controls

The MAIN TUNING control knob operates a three gang variable capacitor C-1 through approximately a 44 to 1 ratio reduction drive mechanism. The main dial has 6 accurately calibrated scales, the scale in use being definitely indicated by band markers appearing at the scale ends. A dial pointer shows the frequency to which the Receiver is tuned. Immediately below the pointer is a vernier dial which may be used to accurately log incoming signals. The accuracy of the calibration can be relied upon to be better than plus or minus 1%.

The tuning system of the NC-2-40CS is truly single control; in fact, the MAIN TUNING control referred to above is used for band changing as well as tuning. To select any one of the six tuning bands, the MAIN TUNING control knob is pulled out about 1/4 inch. When this is done, the dial and capacitor drive mechanism is disengaged and the knob is geared to the coil casting. As the knob is turned, the coil carriage is moved across the chassis until the proper coil pin contacts engage the circuit contactors, as indicated by the

scale markers. Approximately one full turn of the MAIN TUNING knob is required to change from one tuning band to an adjacent tuning band. After the desired band has been selected, the tuning knob is pushed in to its original position, disengaging the coil carriage rack.

The LIMITER control is used to switch on the limiter, and following this, to adjust the threshold at which limiting action starts. When the LIMITER control is turned on (at position 0 on the dial scale) limiting action automatically takes place at a relatively high percentage modulation. Rotating the control clockwise progressively lowers the threshold, or percentage modulation, at which limiting action starts until maximum clipping is achieved at 10. This limiter is double-acting in that limiting is accomplished by the suppression of both positive and negative peaks.

The R.F. GAIN knob is used to adjust the amplification of the R.F. amplifier and two I.F. amplifier tubes. Amplification increases as the control is turned clockwise towards 10.

The CONTROL SWITCH has three pos-

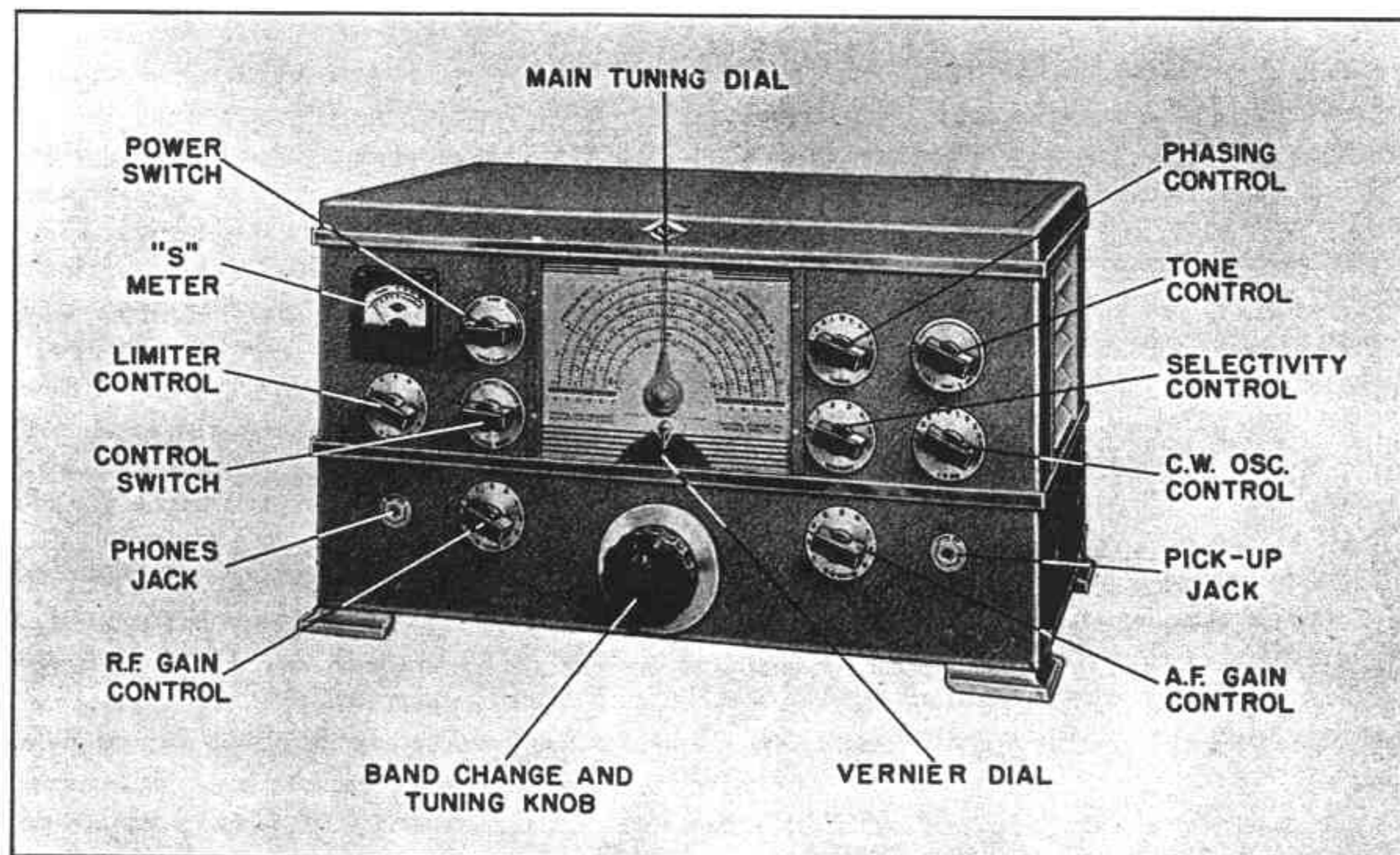

Fig. No. 3. Front View of Receiver

itions marked A.V.C., M.V.C. and C.W.O. respectively. In the A.V.C. position the automatic volume control circuit is in operation and the S-meter is switched on; in the M.V.C. position automatic volume control and S-meter are turned off; in the C.W.O. position, the beat frequency oscillator is switched on and automatic volume control and S-meter are turned off.

The POWER SUPPLY control knob has three positions marked OFF, B+OFF and B+ON, respectively. In the counterclockwise position, OFF, the Receiver is turned off, the primary circuit being opened by the A.C. line switch; in the mid-position B+OFF, the A.C. line switch is turned on but the B supply circuits are incomplete since the B+ switch is opened; in the clockwise position, B+ ON, the B+ switch is closed, completing the B supply circuit. The B+OFF position may thus be used for rendering the Receiver inoperative, as may be required for stand-by purposes during transmission periods.

The PRIMARY SELECTOR SWITCH of the power transformer is mounted on the Receiver chassis to the right of the power transformer. This switch selects the proper circuit arrangement of the dual primary for operation from either 115 or 230 volt power source. There is a shield provided to prevent unintentional throwing of the switch.

The A.F. GAIN control knob is used to adjust the audio amplification of the Receiver. Audio amplification increases as the control is turned towards 10 on the scale.

The PHASING and SELECTIVITY controls are part of the crystal filter. When the SELECTIVITY control is set at OFF, the crystal is switched out of the circuit. With the crystal switched out, the PHASING control has little influence on receiver performance. With the SELECTIVITY control knob set at any point between 1 and 5, inclusive, the crystal filter is in operation, selectivity increasing as the knob is advanced to 5. See Fig No. 1. The PHASING control is then used to balance the crystal bridge circuit and eliminate interfering signals or heterodynes. See Sections 3-2 and 3-3.

The C.W. OSC. control knob is used for varying the frequency of the beat os-

cillator. At 0 on the C.W. OSC. scale, the beat oscillator is tuned to the intermediate frequency of the Receiver. See Section 3-3.

The TONE control knob is used to vary the frequency characteristic of the audio amplifier as previously described. At N on the dial scale normal receiver reproduction is achieved, at position HIGH the low tones are attenuated and rotating the control towards LOW progressively attenuates the high tones.

A BSW terminal panel is mounted at the rear of the receiver chassis. The terminals are connected in parallel with the B+ switch. If external (remote) stand-by control is desired, it can be accomplished by connecting a switch or relay to these terminals.

3-2. Phone Reception

After the equipment is properly installed, in accordance with Section 2, it is placed in operation by adjusting the receiver controls as follows:

1. Set the POWER SUPPLY switch at B+ON.
2. Turn the LIMITER control to the extreme counterclockwise position (off).
3. Set the CONTROL SWITCH at A.V.C.
4. Set the SELECTIVITY switch at OFF.
5. Turn the PHASING control to 0.
6. Turn the P.F. GAIN control to a point between 8 and 10.
7. Turn the A.F. GAIN control to the point providing the desired audio volume.
8. Adjust the TONE control to give the desired audio characteristic.

The Receiver is now adjusted for the reception of phone signals and will tune to the frequency indicated by the MAIN TUNING dial. The C.W. OSC. knob has no influence on receiver performance with the above settings.

With the CONTROL SWITCH set in the A.V.C. position, as recommended, the P.F. GAIN knob should be advanced as far as receiving conditions permit, or until background noise becomes objectionably loud. Audio output should be adjusted entirely by means of the A.F. GAIN knob. The operator must remember that automatic

volume control action will be restricted unless the R.F. GAIN knob is fully advanced.

The CONTROL SWITCH may be set at M.V.C., in which case the operator must be careful not to advance the R.F. GAIN knob to a point where I.F. or audio amplifier overload occurs. Such overload is indicated by distortion. In general, the A.F. GAIN control may be set at about half way on, i.e., at 5 and the audio output adjusted by means of the R.F. GAIN control.

If a signal is weak and partially obscured by background noise and static, best signal-to-noise ratio will be obtained by turning the TONE control toward the LOW position. The most effective setting must be determined by trial as too much attenuation of high audio frequencies may prove undesirable.

When a signal is accompanied by static peaks or noise pulses of high intensity and short duration, the best signal-to-noise ratio will be obtained by turning on the LIMITER control and advancing it as necessary. The best setting must be determined by trial. If static peaks and noise pulses are extremely strong or if they are of fairly long duration, the effectiveness of the limiter will be best with the CONTROL SWITCH in the M.V.C. position. In such cases both R.F. GAIN and LIMITER controls must be carefully adjusted for optimum signal-to-noise ratio.

The selectivity of the Receiver may be adjusted by means of the crystal filter. The normal setting of the SELECTIVITY control in phone reception is at one of the positions affording broad selectivity. Positions OFF, 1 or 2 are recommended. Selectivity may be progressively increased by turning the SELECTIVITY control to positions 3, 4 and 5 although advancing the control too far will increase selectivity to a degree where phone signals become unintelligible.

The PHASING control is used to eliminate or attenuate heterodynes, functioning only when the SELECTIVITY control is at a position other than OFF. The normal setting of the PHASING control in phone reception is at 0 on the scale. If, after a signal has been tuned in, an interfering signal causes a hetero-

dyne or whistle, the PHASING control should be adjusted until the interference is reduced to a minimum. The setting of the PHASING control which provides maximum attenuation of the heterodyne will depend upon the pitch of the heterodyne whistle. If the beat note is above 1,000 cycles, the optimum PHASING control setting will be near 0; if the beat note is 300 or 400 cycles, the optimum PHASING control setting will be near one end of the scale or the other, depending upon whether the interfering signal has a higher or lower frequency than the desired signal.

It is recommended that the TONE control be set in the HIGH position when using the crystal filter in phone reception. The resulting attenuation of low audio frequencies tends to compensate for the side-band cutting action of the crystal filter.

3-3. C.W. Reception

The initial adjustment of the Receiver for C.W. reception is as described in Section 3-2, except that the CONTROL SWITCH must be in the C.W.O. position. The C.W. OSC. control should be set at mid-scale.

The sensitivity of the Receiver is adjusted by means of the R.F. GAIN control, care being taken not to advance the control to the point where strong signals will cause I.F. or audio amplifier overload, as indicated by excessive thumping.

The action of the TONE and LIMITER controls will be similar to that described under Section 3-2. When receiving C.W. signals, it will be possible to advance both TONE and LIMITER controls considerably further than is possible in phone reception, since audio distortion is relatively unimportant.

Turning the C.W. OSC. control will change the characteristic pitch of the Receiver background noise. This control enables the operator to vary the audio beat note of any C.W. signal to a preferred tone. The pitch will become higher as the beat frequency oscillator is detuned from the I.F. amplifier. With the C.W. OSC. control set at 2 or 3 (on either side of 0), the characteristic pitch of the Receiver background noise will be in the neighborhood of 2,000 cycles. Under these conditions, the audio beat note of any C.W.

signal will show a broad peak at approximately 2,000 cycles. This peak will appear on "one side of the carrier" only and the other side, where the audio beat note is around 2,000 cycles, will be considerably weaker. This characteristic, known as "semi-single signal", is helpful in receiving weak signals through interference.

As stated in Section 3-2, the selectivity of the Receiver may be adjusted by means of the crystal filter controls, the action of the SELECTIVITY and PHASING controls in C.W. reception is similar to that described for phone reception. It is possible, however, to utilize the full range of crystal filter selectivity in C.W. reception. Maximum selectivity is obtained with the SELECTIVITY control set at 5. With this setting the single-signal effect, outlined above, becomes very pronounced; in other words, the audio beat note is very sharply peaked at a definite audio frequency which is determined by the setting of the C.W. OSC. control. The operator may have difficulty in finding the audio peak when first attempting to use the crystal filter. After a signal has been accurately

tuned to give peak response, the R.F. GAIN control may need to be retarded in order to prevent I.F. or audio overloading. With the Receiver tuned to "crystal peak", an interfering signal may be attenuated by proper setting of the PHASING knob since this control does not appreciably affect the desired signal.

3-4. Measurement of Signal Strength

To make a measurement of signal strength by means of the S-meter set the Receiver controls as follows: CONTROL SWITCH at A.V.C.; SELECTIVITY at OFF, PHASING at 0. The TONE, LIMITER and A.F. GAIN controls do not affect the meter reading. The setting of the R.F. GAIN control will determine the sensitivity of the S-meter, full sensitivity (See Section 1-8) being obtained with the control at 10. Retarding the R.F. GAIN control to a lower setting than 10 lowers the sensitivity of the S-meter.

Measurement of the signal strength of C.W. signals cannot be made with the beat frequency oscillator in operation.

SECTION 4. SERVICE AND TEST DATA

4-1. Tube Failures

Failure of a vacuum tube in the Receiver may reduce the sensitivity, produce intermittent operation, or cause the equipment to be completely inoperative. In such cases, all tubes should be checked either in an analyzer or similar tube testing equipment, or by replacement with tubes of proven qualities. All tubes should be marked as they are removed from the Receiver so that they may be returned to their original sockets thereby reducing the necessity for realignment.

Individual tubes of the same type will vary slightly in their characteristics and it is well to remember this fact when replacements become necessary. Even though the circuit is designed to reduce the effect of such variations to a minimum, the high frequency oscillator and I.F. tubes should be selected with some care. A replacement high frequency oscillator should be checked in the Receiver to make sure

that the inter-electrode capacities are the same as those of the tube originally employed. This is easily determined by noting any change in dial calibration.

Substitution of new tubes in the I.F. amplifier may possibly alter overall gain and selectivity characteristics. Instructions for realignment are given in detail in Section 5-2.

One other point should be checked when trying the new high frequency oscillator; a fairly strong steady signal should be tuned in, preferably on some frequency above 10 mc.; the beat frequency oscillator should be turned off; jarring the Receiver, or lightly tapping the tube, should not show any evidence of noise in the output.

4-2. Circuit Failures

All component parts of the Receiver have been carefully selected to assure an ample factor of safety. Failure may occur in individual cases and the most common, excluding tubes, will probably be due to

breakdown of a capacitor or resistor. Measurement of voltages in accordance with Section 4-4 will no doubt show where failure has occurred. A by-pass capacitor which has failed may cause overload of associated resistors. These resistors should be checked for any change in resistance. An open capacitor, often the cause of loss of sensitivity or oscillation, may be checked by temporarily connecting a good capacitor across it. Intermittently poor connections can usually be located by lightly tapping each part with a piece of insulating material.

4-3. Stage Gain Measurements

The sensitivity measurements listed below are made with the equipment set up as specified in Section 5-2 except that the CONTROL SWITCH should be set at M.V.C. and the modulation of the signal generator turned on. The high output lead should be attached to the grid of the tube specified in the table below and the ground lead connected to the Receiver chassis. Tune the signal generator between the frequencies of 453 and 457 kilocycles for peak response as indicated on the output meter.

With 1 milliwatt output at the phone jack, the test signal should be within the limits specified below.

Terminal	Test Signal
First Det. Grid..	50 ± 20 Microvolts
First I.F. Grid..	250 ± 50 Microvolts
Sec. I.F. Grid...	50,000 ± 10,000 Microvolts
Sec. Det. Grid...	Over 1 volt

4-4. Voltage Tabulation

All measurements of voltages should be made with the equipment connected for normal operation with a 115 volt, 50/60 cycle or 230 volt, 50/60 cycle A.C. supply. Except as noted, the R.F. GAIN knob is at 10, the LIMITER knob set at OFF and the CONTROL SWITCH knob set at M.V.C. A high-impedance vacuum tube voltmeter should be used since measurements made with an instrument of another type will differ from those listed below. The following table must not be considered as a list of the actual operating voltages since loading effects of the measuring instrument will disturb many of the circuits and alter normal voltage distribution. Measurements are made between terminal and chassis.

Tube Terminal	D.C. Volts ± 15%
R.F. Amp. Grid.....	0
R.F. Amp. Cathode.....	2.4 A
R.F. Amp. Cathode.....	20 B*
R.F. Amp. Screen.....	60 B
R.F. Amp. Plate.....	190 B
First Det. Grid.....	0
First Det. Cathode.....	1 A
First Det. Screen.....	55 B
First Det. Plate.....	185 B
H.F. Osc. Grid.....	-7 A
H.F. Osc. Cathode.....	0
H.F. Osc. Plate.....	115 B
First I.F. Grid.....	0
First I.F. Cathode.....	4 A
First I.F. Cathode.....	20 B*
First I.F. Screen.....	60 B
First I.F. Plate.....	185 B
Sec. I.F. Grid.....	0
Sec. I.F. Cathode.....	5 A
Sec. I.F. Cathode.....	19 B*
Sec. I.F. Screen.....	75 B
Sec. I.F. Plate.....	185 B
Sec. Det. Grid.....	70 B
Sec. Det. Cathode.....	5 A
Sec. Det. Plate.....	185 B
Limiter Grid.....	-27 BD
Limiter Cathode.....	-21 B
Limiter Cathode.....	0 D
Limiter Plate.....	0
A.V.C. Grid.....	-50 BE
A.V.C. Cathode.....	-45 AE
A.V.C. Screen.....	0 E
A.V.C. Plate.....	0 E
B.F. Osc. Grid.....	C
B.F. Osc. Cathode.....	0 F
B.F. Osc. Screen.....	18 BF
B.F. Osc. Plate.....	45 BF
Amp.-Inv. Grids.....	0
Amp.-Inv. Cathode.....	4 A
Amp.-Inv. Plates.....	100 B
Audio Grids.....	-40 B
Audio Cathodes.....	-50 B
Audio Screens.....	190 B
Audio Plates.....	180 B
B+ Common.....	195 B
B - Common.....	-65 B

- A--0 to 10 volt meter scale
- B--0 to 300 volt meter scale
- C--Accurate measurement cannot be made
- D--LIMITER knob set at 10
- E--CONTROL SWITCH knob set at A.V.C.
- F--CONTROL SWITCH knob set at C.W.O.
- *--R.F. GAIN knob set at 0

SECTION 5. ALIGNMENT DATA**5-1. General**

All circuits are carefully aligned, before shipment, using precision crystal oscillators which insure close conformability to the dial calibration. No readjustment will be required, therefore, unless the Receiver is tampered with or damaged.

To determine the necessity for realignment, the Receiver should first be carefully checked against its normal performance as described in Section 3. In no case should realignment be attempted unless tests indicate that such realignment is necessary. Even then, it must be remembered that the NC-2-40CS is a communications Receiver and should not be serviced or realigned by any individual who does not have a complete understanding of the functioning of the equipment and who has not had previous experience adjusting a similar type of Receiver.

A screwdriver having a metal shaft may be used to make adjustments in the high frequency circuits but capacity effects will be noticeable, and the shaft should not touch any part of the aluminum casting.

Before proceeding with the alignment of any circuit of the Receiver, the equipment must be set up as specified in Section 2, except that the antenna lead-in or transmission line must be disconnected. An output meter should be connected to one of the output terminals, making sure that the resistive load of the output meter matches the impedance of the output terminal used.

Alignment of the equipment may be divided into two major steps:

- (1) I.F. Amplifier Alignment
- (2) H.F. Circuits Alignment
 - (a) H.F. Oscillator
 - (b) First Detector and R.F. Amplifier

The circuits **MUST** be tuned in the above order when complete alignment is necessary.

5-2. I.F. Amplifier Alignment

The intermediate frequency of the NC-2-40CS Receiver is 455 kilocycles, plus or minus 2 kilocycles. The exact frequency is determined by the quartz crystal resonator Y-1.

Tuning capacitors are provided on the crystal filter, each I.F. transformer and on the C.W. oscillator transformer. These capacitors are designated on Fig. Nos. 4 and 5.

The preliminary alignment procedure is as follows:

(1) Connect the high output lead of an accurately calibrated signal generator to the grid terminal (cap) of the first detector tube and the grounded lead to any convenient grounded point on the chassis. The flexible lead need not be disconnected from the grid of the tube. This is a direct connection, no dummy antenna is required.

(2) Set the CONTROL SWITCH at C.W.O.

(3) Set the SELECTIVITY control at 5.

(4) Turn the PHASING control to 0.

(5) Turn the A.F. GAIN control to 10.

(6) Turn the R.F. GAIN control to 10.

(7) Set the TONE control at N.

(8) Turn the LIMITER control off.

(9) Set the POWER Supply knob at **B+ ON**.

(10) Turn the modulation of the signal generator off to provide a steady C.W. test signal.

Adjust the output attenuator of the signal generator to provide a signal of approximately 100 microvolts and vary the tuning control of the signal generator slowly between the frequencies of 453 and 457 kilocycles. At some frequency between these limits the I.F. amplifier of the Receiver will show a very sharply peaked response, as indicated on the output meter. This frequency is that of the crystal, Y-1, and I.F. alignment, as outlined below, is made to this frequency. The output attenuator of the signal generator should be retarded after the signal generator has been tuned to the I.F. peak in order to avoid I.F. or audio overload; the C.W. OSC. control must be set to provide an audio beat note in the middle of the audio range (between 400 and 1,000 cycles).

The I.F. tuning capacitors C-39,

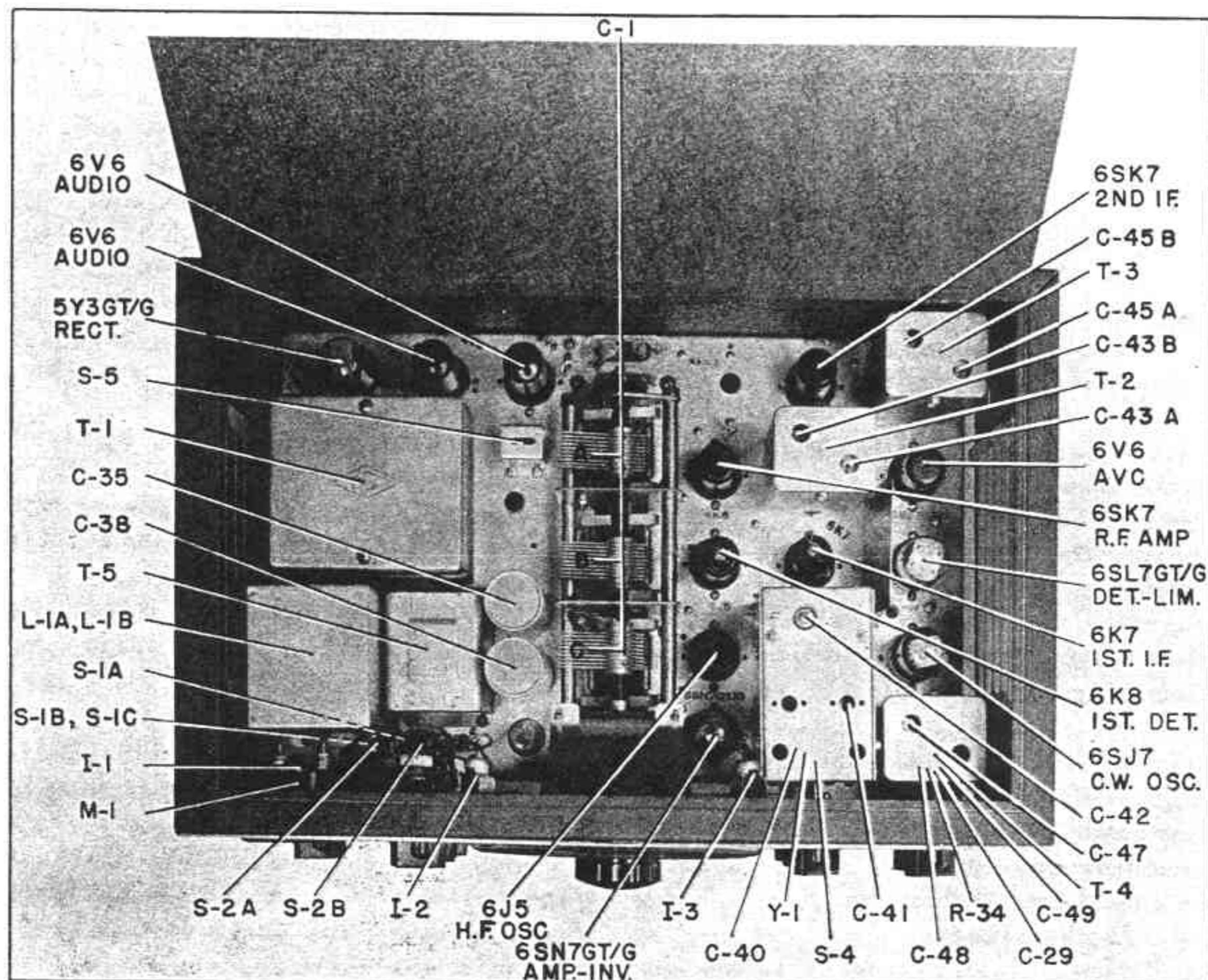

Fig. No. 4. Top View of Receiver

C-43A, C-43B, C-45A and C-45B should each be carefully adjusted to give a maximum reading on the output meter. The order in which the adjustments are made is not important. While making I.F. amplifier adjustments, it will be necessary to retard the attenuator of the signal generator if the readjustment increases I.F. amplifier gain to the point where overload occurs.

The crystal filter SELECTIVITY knob should then be set at 1 and the signal generator detuned between 3 and 4 kilocycles either side of the crystal frequency. Capacitor C-42 should be tuned for maximum output meter reading. After this adjustment is made, the SELECTIVITY knob should be set at OFF and the signal generator retuned to exact crystal frequency. Compensator capacitor C-41 should then be adjusted for maximum reading on the output meter.

The performance of the I.F. amplifier and audio circuits may be checked against

the stage gain data in Section 4-3 after alignment has been completed. Selectivity may be checked against the curves of Fig. No. 1.

After alignment of the I.F. amplifier has been completed, the C.W. OSC. control should be set at 0 at which setting the C.W. oscillator should be at zero beat with the test signal. If zero beat does not occur at zero, readjust capacitor C-47 of transformer T-4. See Fig. No. 4.

The quartz crystal resonator Y-1 may be checked at the conclusion of I.F. amplifier alignment as follows: The SELECTIVITY control should be set at 5 and the signal generator tuned to the crystal frequency. The output meter reading should be noted. When the SELECTIVITY knob is turned to OFF, the meter reading should decrease 1 to 2 db. provided the PHASING knob is at 0. An increase in meter reading can, in most cases, be traced to an improper adjustment in the

I.F. amplifier, since the crystal resonator is mounted in a sealed holder, and it is rather unlikely that trouble will be had from that source.

5-3-H.F. Circuits Alignment

The data given in this section applies to the alignment of the H.F. oscillator, first detector and R.F. amplifier stages. The Alignment Chart at the close of this section gives the specific dial check points and circuit adjustments to use in affecting alignment.

The coil group which is plugged into the circuit at any time is the one directly underneath the three gang master tuning capacitor. The coil nearest the front panel of the Receiver is in the H.F. oscillator circuit, the middle coil is in the first detector circuit and the coil nearest the antenna input terminal panel is in the R.F. amplifier circuit. See Fig. No. 6.

All coils have individual trimmer capacitors. The H.F. oscillator circuits of tuning bands E & F have, also, variable series padding capacitors. These capacitors are identified in Fig. No. 6.

(a) H.F. oscillator

The original alignment is accomplished at National Laboratories by the use of precision crystal-controlled test oscillators. No realignment of the H.F. oscillator circuits should be attempted unless a test signal source with an accuracy of better than 1% is available. The need of realignment of the H.F. oscillator is indicated when the frequency calibration of the Receiver is in error by more than 2% at the check point at the high frequency end of any one band. Particular care should be taken when adjusting the H.F. oscillator trimmers. It is imperative that the high frequency oscillator is set to operate at a frequency above the first detector and R.F. amplifier frequency and not below. This can be checked by tuning in the image signal which should appear 910 kilocycles lower on the receiver dial. If it is found that the image signal does not appear at this setting the H.F. oscillator is incorrectly aligned and the capacity of the H.F. oscillator trimmer must be decreased until the image and fundamental signals appear at the correct setting. After the H.F. oscillator has been correctly calibrated at the high-frequency check point of each band,

calibration should be checked at the low-frequency check point of each band and correction made as necessary. Bands A, B, C and D have an inductance adjustment, L-4, and bands E and F have a variable series padding capacitor, C-53, for calibration purposes at the low-frequency check point.

(b) First Detector and R.F. Amplifier

After the H.F. oscillator has been correctly calibrated the first detector and R.F. amplifier trimmer capacitors C-51 and C-50, respectively, should be adjusted for maximum receiver gain as indicated on the output meter.

Tracking at the low-frequency check point should then be checked and corrections made as required. Bands A, B, C and D have an inductance adjustment L-2 and L-3, to affect tracking corrections. Tracking may be checked by two methods:

(1) Insert a tuning wand into the opening of the coil form of the stage under test. Receiver gain should decrease the same amount on insertion of the iron or brass end of the tuning wand.

(2) Test the settings of the first detector and R.F. amplifier trimmers for maximum gain. The stage is tracking properly if the trimmer does not require a change in capacity. After such a test, all trimmers checked should be reset at the high-frequency check point of the band.

5-4. S-Meter Adjustment

The S-meter circuit in the NC-2-40CS insures the stability of the zero reading of the S-meter and requires no electrical adjustment. A check of the mechanical zero setting can be made with the Receiver off. If the S-meter does not read true zero the screw adjustment on the bezel of the meter is provided to correct any inaccuracy.

5-5. Band Indicator Adjustment

A means of centering the band indicator markers in the horizontal slots of the dial face is provided. The adjustment is located on the underside of the chassis. See Figure No. 6. To make any adjustment it is necessary to remove the bottom cover and coil carriage cover of the Receiver and to move the coil carriage into the proper position for operation on band C or band D. The position of the indicator markers is controlled by the dial cord wound on the two studs protruding from the coil car-

riage. Centering of the band indicator markers is accomplished as follows:

(1) Grasp the stud protruding from the F band H.F. oscillator compartment firmly with a pair of pliers or wrench.

(2) Loosen the nut on the inside of the coil carriage about one turn and at the same time retain a firm grip on the stud. The cord is spring wound onto the stud and

if the stud is not held firmly the cord will spring off and unwind.

(3) Rotate the stud slowly in the proper direction until the correct band marker appears in the center of the dial slot.

(4) Tighten the nut securely and check to see that the proper adjustment is retained.

ALIGNMENT CHART

Step	Band	Adjust Signal Source To:	Set Dial At:	H.F. Oscillator Adjustments		1st. Det. & R.F. Amp. Adjust. Adjust For Maximum Output
				Receive	Test Signal	
1	A	30.0 Mc.	30.0 Mc.	C-52		C-50, C-51
2	A	15.0 Mc.	15.0 Mc.	L-4		L-2, L-3
3	A	30.0 Mc.	30.0 Mc.			Check step 1. Repeat steps 1, 2 and 3 if necessary.
1	B	14.0 Mc.	14.0 Mc.	C-52		C-50, C-51
2	B	7.0 Mc.	7.0 Mc.	L-4		L-2, L-3
3	B	14.0 Mc.	14.0 Mc.			Check step 1. Repeat steps 1, 2 and 3 if necessary.
1	C	7.0 Mc.	7.0 Mc.	C-52		C-50, C-51
2	C	4.0 Mc.	4.0 Mc.	L-4		L-2, L-3
3	C	7.0 Mc.	7.0 Mc.			Check step 1. Repeat steps 1, 2 and 3 if necessary.
1	D	4.0 Mc.	4.0 Mc.	C-52		C-50, C-51
2	D	2.0 Mc.	2.0 Mc.	L-4		L-2, L-3
3	D	4.0 Mc.	4.0 Mc.			Check step 1. Repeat steps 1, 2 and 3 if necessary
1	E	2.0 Mc.	2.0 Mc.	C-52		C-50, C-51
2	E	1.0 Mc.	1.0 Mc.	C-53		
3	E	2.0 Mc.	2.0 Mc.			Check step 1. Repeat steps 1, 2 and 3 if necessary.
1	F	400 Kc.	400 Kc.	C-52		C-50, C-51
2	F	200 Kc.	200 Kc.	C-53		
3	F	400 Kc.	400 Kc.			Check step 1. Repeat steps 1, 2 and 3 if necessary.

NOTE--Inductance adjustment, L- , is a loop of wire inside coil form--bending the loop in one direction or the other varies the inductance.

SECTION 6.

PARTS LIST

Symbol	Function	Type	Rating
CAPACITORS			
C-1	Main Tuning.....	Air	225 mmf. max./sec.
C-1A	R.F. Amp. Tuning.....	Air	Part of C-1
C-1B	1st. Det. Tuning.....	Air	Part of C-1
C-1C	H.F. Osc. Tuning.....	Air	Part of C-1
C-2	R.F. Grid Filter.....	Mica	.005 mfd., 300 vdcw
C-3	R.F. Cathode Bypass.....	Paper	.1 mfd., 400 vdcw
C-4	R.F. Screen Bypass.....	Paper	.1 mfd., 400 vdcw
C-5	F.F. B+ Bypass.....	Paper	.1 mfd., 600 vdcw
C-6	1st. Det. Cathode Bypass.....	Paper	.1 mfd., 400 vdcw
C-7	1st. Det. Screen Bypass.....	Paper	.1 mfd., 400 vdcw
C-8	1st. Det. B+ Bypass.....	Paper	.1 mfd., 600 vdcw
C-9	1st. I.F. Grid Filter.....	Paper	.01 mfd., 600 vdcw
C-10	1st. I.F. Cathode Bypass.....	Paper	.1 mfd., 400 vdcw
C-11	1st. I.F. B+ Bypass.....	Paper	.1 mfd., 600 vdcw
C-12	2nd. I.F. Grid Filter.....	Paper	.01 mfd., 600 vdcw
C-13	2nd. I.F. Cathode Bypass.....	Paper	.1 mfd., 400 vdcw
C-14	2nd. I.F. Screen Bypass.....	Paper	.1 mfd., 400 vdcw
C-15	2nd. I.F. B+ Bypass.....	Paper	.1 mfd., 600 vdcw
C-16	2nd. Det. Plate Bypass.....	Paper	.01 mfd., 600 vdcw
C-17	2nd. Det. to Limiter Audio Coupling....	Paper	1.0 mfd., 200 vdcw
C-18	2nd. Det. Cathode Bypass.....	Ceramic	250 mmf., 500 vdcw
C-19	2nd. Det. I.F. Bypass.....	Mica	.001 mfd., 500 vdcw
C-20	Limiter Output Bypass.....	Ceramic	250 mmf., 500 vdcw
C-21	Tone Control.....	Paper	.01 mfd., 600 vdcw
C-22	Limiter to Inverter Audio Coupling....	Paper	.01 mfd., 600 vdcw
C-23	Tone Control.....	Mica	.001 mfd., 500 vdcw
C-24	Inverter-Audio Cathode.....	Elec.	10 mfd., 50 vdcw
C-25	Inverter-Audio to Output Coupling....	Paper	.1 mfd., 400 vdcw
C-26	Inverter-Audio to Output Coupling....	Paper	.1 mfd., 400 vdcw
C-27	Inverter-Feedback Coupling.....	Paper	.1 mfd., 400 vdcw
C-28	H.F. Osc. Grid.....	Ceramic	250 mmf., 500 vdcw
C-29	C.W. Osc. Grid.....	Mica	.001 mfd., 500 vdcw
C-30	C.W. Osc. Screen Bypass.....	Paper	.1 mfd., 400 vdcw
C-31	C.W. Osc. to Sec. Det. Coupling.....	Ceramic	2 mmf., 500 vdcw
C-32	A.V.C. Output Bypass.....	Paper	.1 mfd., 400 vdcw
C-33	A.V.C. Plate Bypass.....	Paper	.1 mfd., 400 vdcw
C-34	A.V.C. Cathode Bypass.....	Paper	.1 mfd., 400 vdcw
C-35	B Minus Bypass.....	Elec.	40 mfd., 200 vdcw
C-36	Not used.....		
C-37	Power Supply Filter.....	Paper	.1 mfd., 600 vdcw
C-38	Power Supply Filter.....	Elec.	8+8 mfd., 475 vdcw
C-39	Crystal Filter Input Tuning.....	Air	6-85 mmf.
C-40	Crystal Filter Phasing Control.....	Air	5+5 mmf.
C-41	Crystal Filter Compensating.....	Mica	5-30 mmf.
C-42	Crystal Filter Output Tuning.....	Air	6-85 mmf.

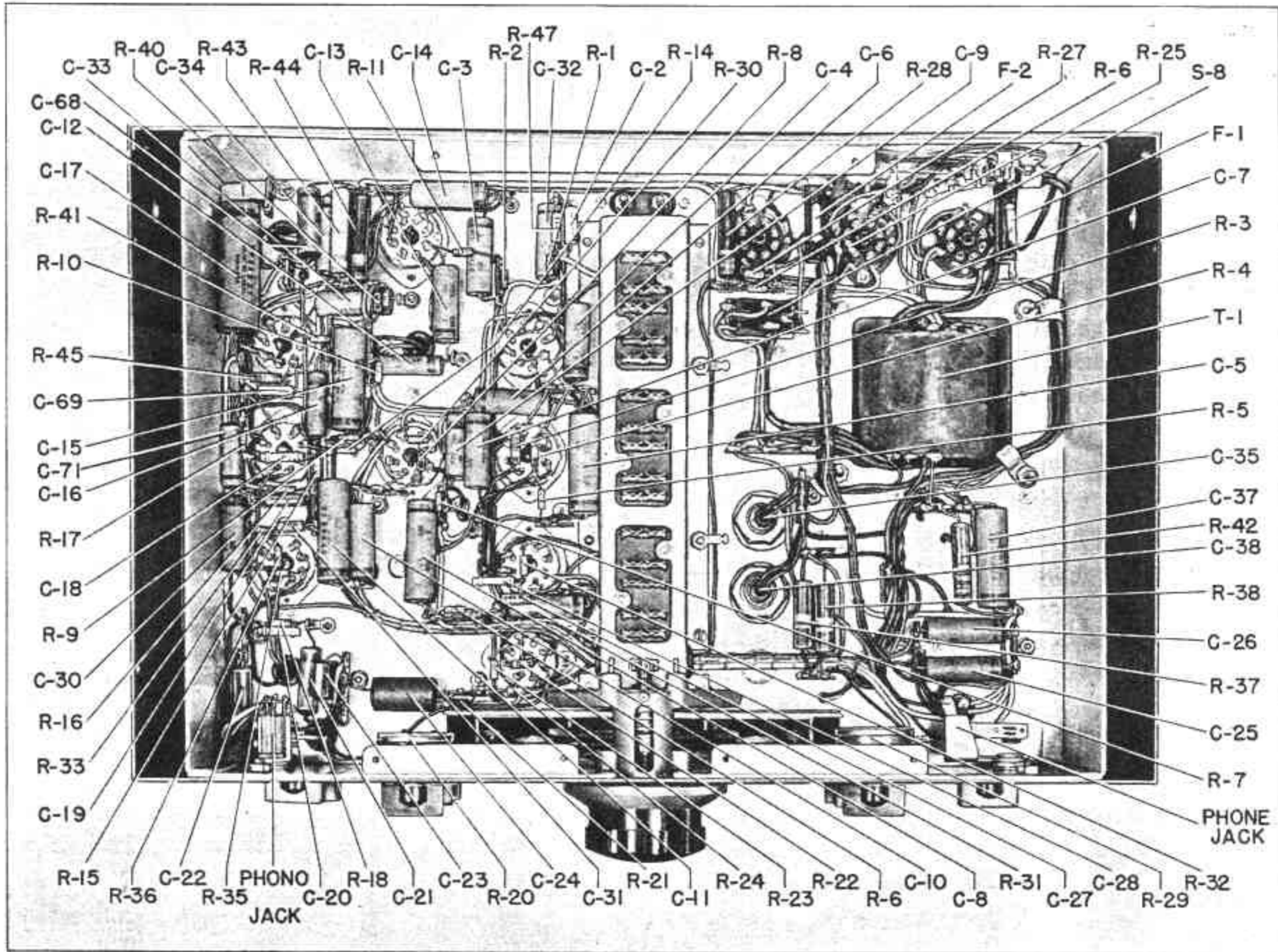

Fig. No. 5. Bottom View of Receiver with Coil Carriage Removed

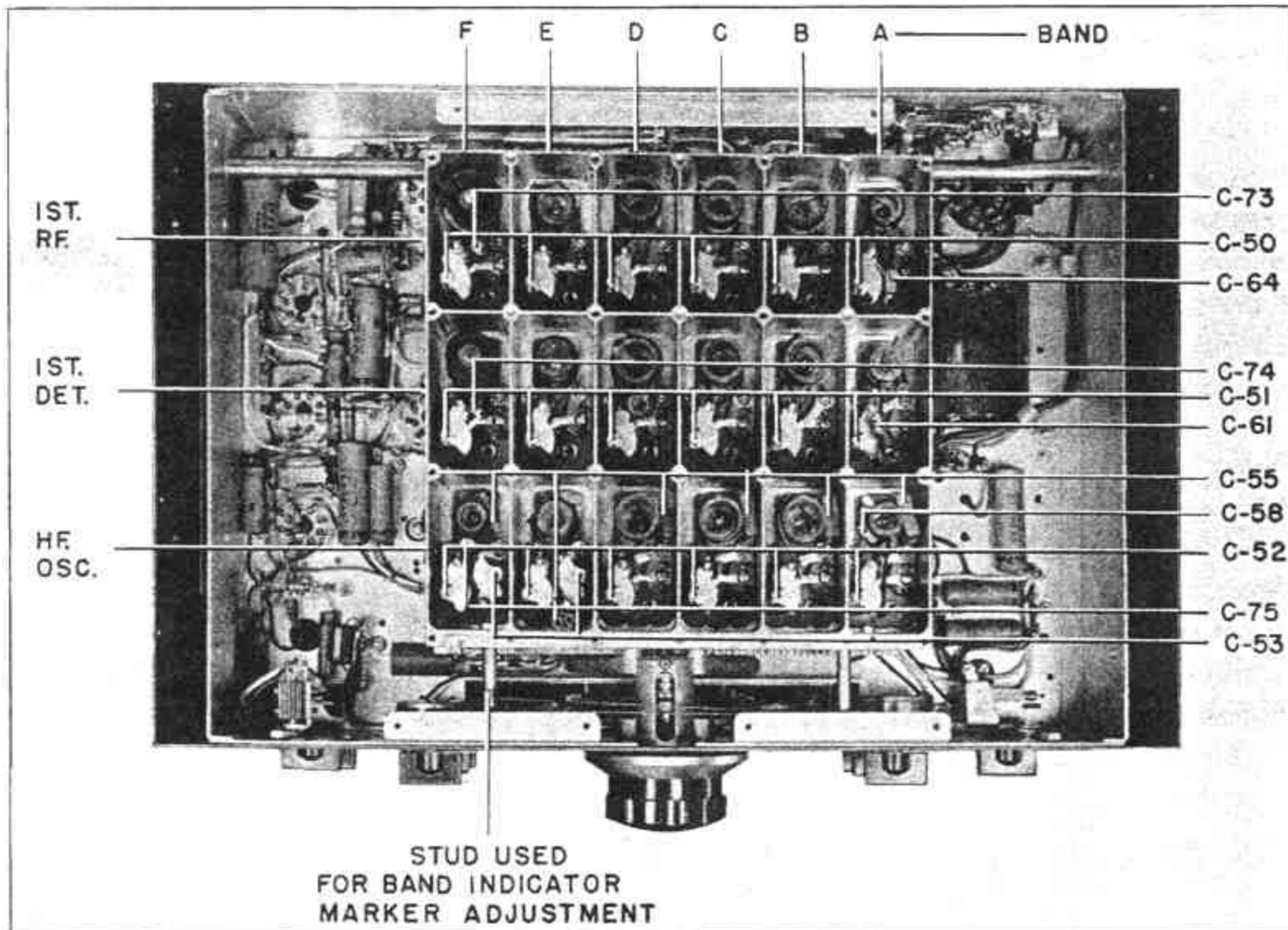

Fig. No. 6. Bottom View of Receiver with Coil Carriage Cover Removed

PARTS LIST (Continued)

Symbol	Function	Type	Rating
CAPACITORS (Continued)			
C-43	T-2 Tuning.....	Air	6-85 mmf./sec.
C-43A	T-2 Primary Tuning.....	Air	Part of C-43
C-43B	T-2 Secondary Tuning.....	Air	Part of C-43
C-44	Not used		
C-45	T-3 Tuning.....	Air	6-85 mmf./sec.
C-45A	T-3 Primary Tuning.....	Air	Part of C-45
C-45B	T-3 Secondary Tuning.....	Air	Part of C-45
C-46	Not used		
C-47	T-4 Tuning.....	Air	6-85 mmf.
C-48	C.W. Osc. Control.....	Air	1-10 mmf.
C-49	C.W. Osc. Compensating.....	Ceramic	10 mmf., 500 vdcw
C-50	R.F. Amp. Trimmer, All Bands.....	Air	
C-51	1st. Det. Trimmer, All Bands.....	Air	
C-52	H.F. Osc. Trimmer, All Bands.....	Air	
C-53	E & F Bands H.F. Osc. Trimmer.....	Air	
C-54	Not used		
C-55	A Band H.F. Osc. Padder.....	Mica	750 mmf., 500 vdcw
	B Band H.F. Osc. Padder.....	Mica	.003 mfd., 500 vdcw
	C Band H.F. Osc. Padder.....	Mica	.0017 mfd., 500 vdcw
	D Band H.F. Osc. Padder.....	Mica	900 mmf., 500 vdcw
	E Band H.F. Osc. Padder.....	Ceramic	525 mmf., 500 vdcw
	F Band H.F. Osc. Padder.....	Ceramic	100 mmf., 500 vdcw
C-56	Not used		
C-57	Not used		
C-58	A Band H.F. Osc. Feedback Compensating.	Ceramic	29 mmf., 500 vdcw
C-59	Not used		
C-60	Not used		
C-61	A Band 1st. Det. Coupling.....	Ceramic	16 mmf., 500 vdcw
C-62	Not used		
C-63	Not used		
C-64	A Band R.F. Amp. Padder.....	Mica	900 mmf., 500 vdcw
C-65	Crystal Filter Bridge.....	Ceramic	62 mmf., 500 vdcw
C-66	Crystal Filter Bridge.....	Ceramic	47 mmf., 500 vdcw
C-67	Phasing Compensating.....	Mica	5-30 mmf.
C-68	2nd. Det. Grid Filter.....	Paper	.1 mfd., 400 vdcw
C-69	A.V.C. Grid.....	Mica	.001 mfd., 500 vdcw
C-70	Not used		
C-71	Limiter Plate Bypass.....	Paper	.1 mfd., 400 vdcw
C-72	Not used		
C-73	F Band R.F. Amp. Trimmer.....	Ceramic	20 mmf., 500 vdcw
C-74	F Band 1st. Det. Pri. to Sec. Coupling.	Ceramic	2 mmf., 500 vdcw
C-75	F Band H.F. Osc. Trimmer.....	Ceramic	25 mmf., 500 vdcw

PARTS LIST (Continued)

Symbol	Function	Type	Rating
RESISTORS			
R-1	R.F. Grid Filter.....	Fixed	470,000 Ohms 1/2 w
F-2	R.F. Cathode Bias.....	Fixed	470 Ohms 1/2 w
R-3	1st. Det. Cathode Bias.....	Fixed	220 Ohms 1/2 w
R-4	1st. Det. Screen Bleeder.....	Fixed	100,000 Ohms 1/2 w
R-5	1st. Det. Screen Dropping.....	Fixed	47,000 Ohms 1/2 w
R-6	1st. Det. Plate Filter.....	Fixed	2,200 Ohms 1/2 w
R-7	1st. I.F. Grid Filter.....	Fixed	22,000 Ohms 1/2 w
R-8	1st. I.F. Cathode Bias.....	Fixed	See Note No. 1 1/2 w
R-9	1st. I.F. Plate Filter.....	Fixed	2,200 Ohms 1/2 w
R-10	2nd. I.F. Grid Filter.....	Fixed	470,000 Ohms 1/2 w
R-11	2nd. I.F. Cathode Bias.....	Fixed	See Note No. 1 1/2 w
R-12	Not used		
R-13	Not used		
R-14	2nd. Det. Plate Filter.....	Fixed	2,200 Ohms 1/2 w
F-15	2nd. Det. I.F. Filter.....	Fixed	4,700 Ohms 1/2 w
F-16	2nd. Det. Load.....	Fixed	22,000 Ohms 1/2 w
R-17	Limiter Input.....	Fixed	15,000 Ohms 1/2 w
R-18	Limiter Output.....	Fixed	47,000 Ohms 1/2 w
R-19	Tone Control.....	Var.	500,000 Ohms 1 w
R-20	A.F. Gain Control.....	Var.	500,000 Ohms 1 w
R-21	Inverter-Audio Cathode Bias.....	Fixed	1,000 Ohms 1/2 w
R-22	Inverter-Grid.....	Fixed	470,000 Ohms 1/2 w
R-23	1st. Audio Plate.....	Fixed	47,000 Ohms 1/2 w
R-24	1st. Audio Plate.....	Fixed	47,000 Ohms 1/2 w
F-25	Output Grid.....	Fixed	220,000 Ohms 1/2 w
F-26	Output Grid.....	Fixed	220,000 Ohms 1/2 w
R-27	Inverter Feedback Coupling.....	Fixed	220,000 Ohms 1/2 w
R-28	Output Cathode Bias.....	Fixed	220 Ohms 2 w
R-29	R.F. Gain Control.....	Var.	10,000 Ohms 1 w
R-30	R.F. Gain Bleeder.....	Fixed	47,000 Ohms 1/2 w
R-31	H.F. Osc. B+ Dropping.....	Fixed	47,000 Ohms 1 w
R-32	H.F. Osc. Grid.....	Fixed	47,000 Ohms 1/2 w
R-33	C.W. Osc. Plate Filter.....	Fixed	470,000 Ohms 1/2 w
R-34	C.W. Osc. Grid.....	Fixed	47,000 Ohms 1/2 w
R-35	C.W. Osc. Screen Bleeder.....	Fixed	100,000 Ohms 1/2 w
R-36	C.W. Osc. Screen Dropping.....	Fixed	100,000 Ohms 1/2 w
R-37	B+ Voltage Divider.....	Fixed	22,000 Ohms 2 w
R-38	B+ Voltage Divider.....	Fixed	22,000 Ohms 2 w
R-39	Not used		
R-40	2nd. I.F. Filter.....	Fixed	100,000 Ohms 1/2 w
R-41	A.V.C. Plate Filter.....	Fixed	470,000 Ohms 1/2 w
R-42	A.V.C. Voltage Divider.....	Fixed	10,000 Ohms 2 w
R-43	A.V.C. Voltage Divider.....	Fixed	2,700 Ohms 2 w
R-44	A.V.C. Cathode Bias.....	Fixed	820 Ohms 2 w

PARTS LIST (Continued)

Symbol	Function	Type	Rating
RESISTORS (Continued)			
R-45	A.V.C. Grid.....	Fixed	1,000,000 Ohms 1/2 w
R-46	Limiter Control.....	Var.	10,000 Ohms 1 w
R-47	A.V.C. Bleeder.....	Fixed	1,500,000 Ohms 1/2 w
MISCELLANEOUS			
CF-1	Crystal Filter.....	Air Tuned	
F-1	A.C. Line Fuse.....		2 Amp., 250 Volt
F-2	A.C. Line Fuse.....		1 Amp., 250 Volt
I-1	S Meter Lamp.....	No. 40	6-8 V., .15 Amp.
I-2	Dial Lamp.....	No. 47	6-8 V., .15 Amp.
I-3	Dial Lamp.....	No. 47	6-8 V., .15 Amp.
J-1	Phone Jack.....	Multi-Ckt.	
J-2	Pick-Up Jack.....	Multi-Ckt.	
L-1A	Filter Choke.....		17 h., 100 ma.
L-1B	Filter Choke.....		17 h., 100 ma.
L-2	F.F. Amp. Inductor.....		
L-3	1st. Det. Inductor.....		
L-4	H.F. Osc. Inductor.....		
M-1	Signal Strength Meter.....		0 to 1 ma.
P-1	Loudspeaker Cable and Plug.....		5 Prong
P-2	Dummy Plug.....		7 Prong
P-3	Battery Plug.....		7 Prong
S-1	Control Switch.....		Two Gang, 250 V., 1A
S-1A	C.W. Osc. Switch.....	S.P.S.T.	Part of S-1
S-1B	A.V.C. Switch.....	S.P.S.T.	Part of S-1
S-1C	S Meter Switch.....	S.P.S.T.	Part of S-1
S-2	Power Supply Switch.....		Two Gang, 250 V., 1A
S-2A	A.C. Switch.....	S.P.S.T.	Part of S-2
S-2B	B+ Switch.....	S.P.S.T.	Part of S-2
S-3	Tone Control Switch.....		Part of P-19
S-4	Selectivity Switch.....		2 Section, Ganged
S-5	T-1 Primary Selection Switch.....	D.P.D.T.	250 V., 3A
S-6	Limiter Switch.....		Part of R-46
T-1	Power Transformer.....		115/230 V., 60 cycle
T-2	2nd. I.F. Transformer.....		455 kc.
T-3	Det. Input Transformer.....		455 kc.
T-4	C.W. Osc. Transformer.....		455 kc.
T-5	Audio Output Transformer.....		10 watts
X-1	Audio Output Socket.....		5 Prong
X-2	Battery Socket.....		7 Prong
X-3	8 Ohm Terminal Strip.....		2 Connector
X-4	500 Ohm Terminal Strip.....		2 Connector
Y-1	Crystal Resonator.....		455 kc.
<p>Note No. 1:- Individually chosen to meet the circuit requirements of each Receiver.</p>			

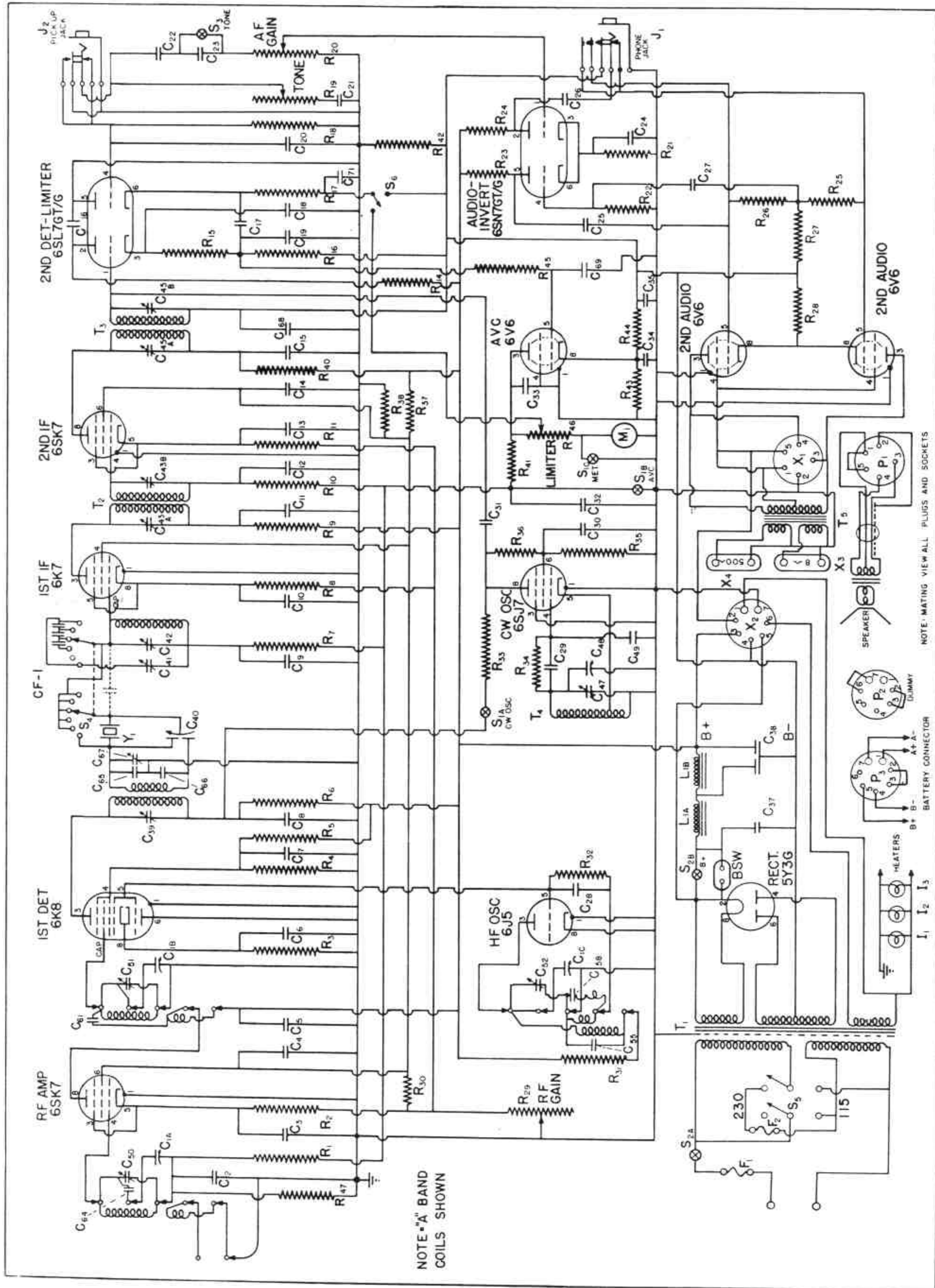

Fig. No. 7. NC-2-40CS Receiver Schematic Diagram

Standard Form Warranty

Adopted by the Radio Manufacturers Association, Inc.

This equipment is warranted to be free from defective material and workmanship and repair or replacement will be made of any part which under normal installation, use and service discloses defect, provided the unit is delivered by the owner to the manufacturer or through the authorized radio dealer or wholesaler from whom purchased, intact, for examination, with all transportation charges prepaid to the factory, within ninety days from the date of original shipment from the factory, and provided that such examination discloses in the manufacturer's judgment that it is thus defective.

This warranty does not extend to any radio products which have been subjected to misuse, neglect, accident, incorrect wiring, improper installation, or to use in violation of instructions furnished by the manufacturer, nor extend to units which have been repaired or altered outside of the factory, nor to cases where the serial number thereof has been removed, defaced or changed, nor to accessories used therewith of other manufacture.

Any part of a unit approved for remedy or exchange hereunder will be remedied or exchanged by the authorized radio dealer or wholesaler without charge to the owner.

This warranty is in lieu of all other warranties expressed or implied and no representative or person is authorized to assume for the manufacturer any other liability in connection with the sale of their radio products.

National Company, Inc. reserves the right to make any change in design or to make addition to, or improvements in, its products without imposing any obligations upon itself to install them in its products previously manufactured.

THE NATIONAL NC-2-40CS RECEIVER

Equipment List

NC-2-40CST Receiver, table mounting, grey finish, complete with tubes, crystal filter, noise limiter, 115 and 230 volt, 50/60 cycle built-in power supply.

NC-2TSG 10" PM Loudspeaker in matching cabinet for the above Receiver.

NC-2-40CSR, same as above Receiver but mounted on a $\frac{1}{8}$ " steel, standard rack panel $10\frac{1}{2}$ " high, grey finish.

NC-2RS 10" PM Loudspeaker mounted on a $\frac{1}{8}$ " steel, standard rack panel $10\frac{1}{2}$ " high, grey finish.

Prices on Application



National Co., Inc., Malden, Mass., U.S.A.—



NATIONAL COMPANY, INC.
MALDEN, MASS.
U. S. A.